

CELESTIAL PARTICLE
TRANSMUTER

FIG 1

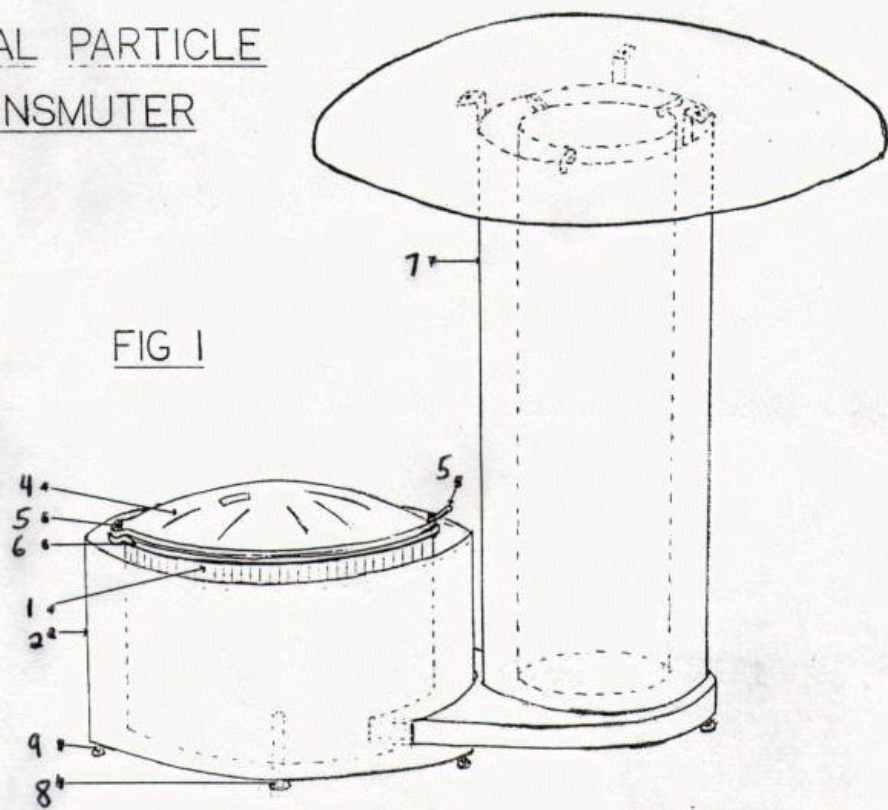

FIG 2



FIG 5

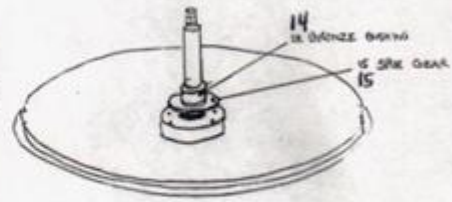

FIG 3

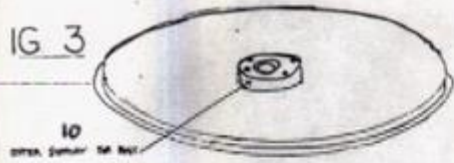

FIG 6

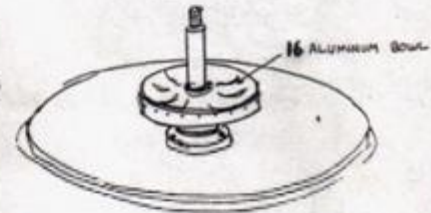

FIG 4

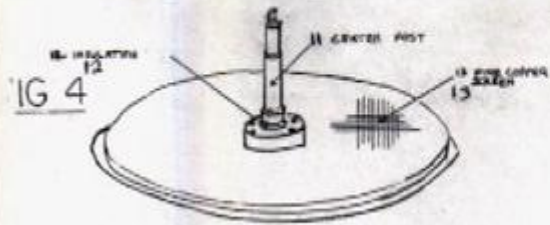
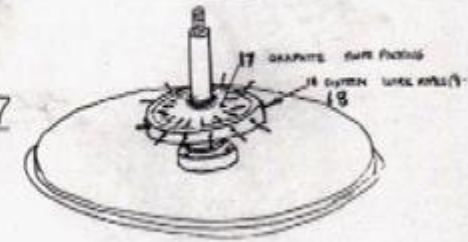

FIG 7



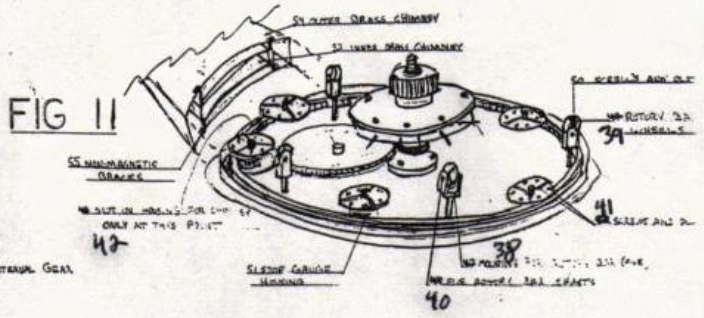
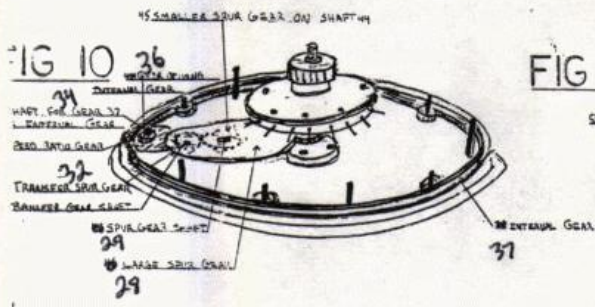
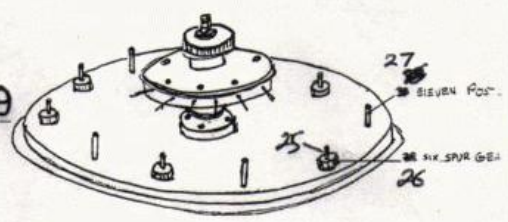
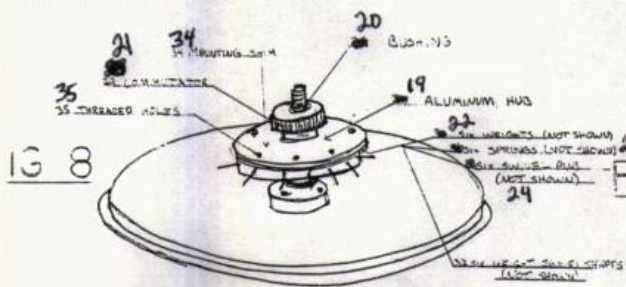

FIG 12

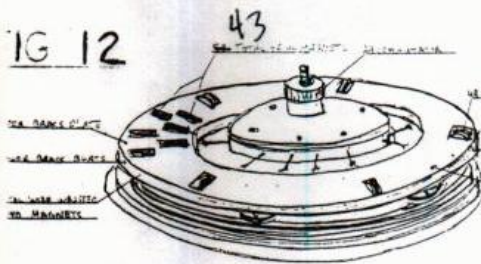

FIG 13

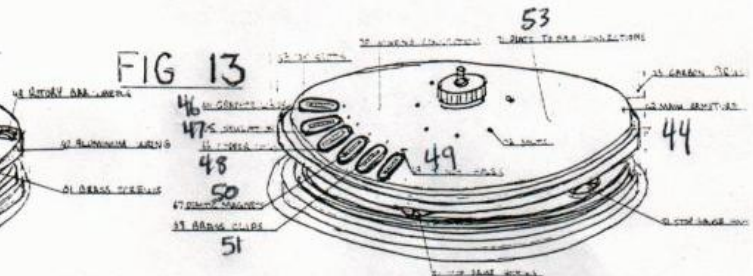

FIG 14

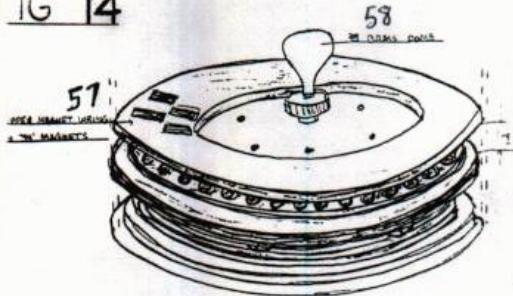
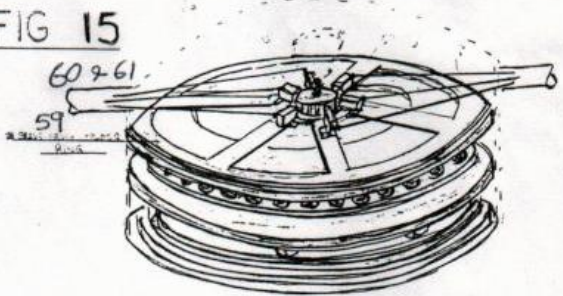
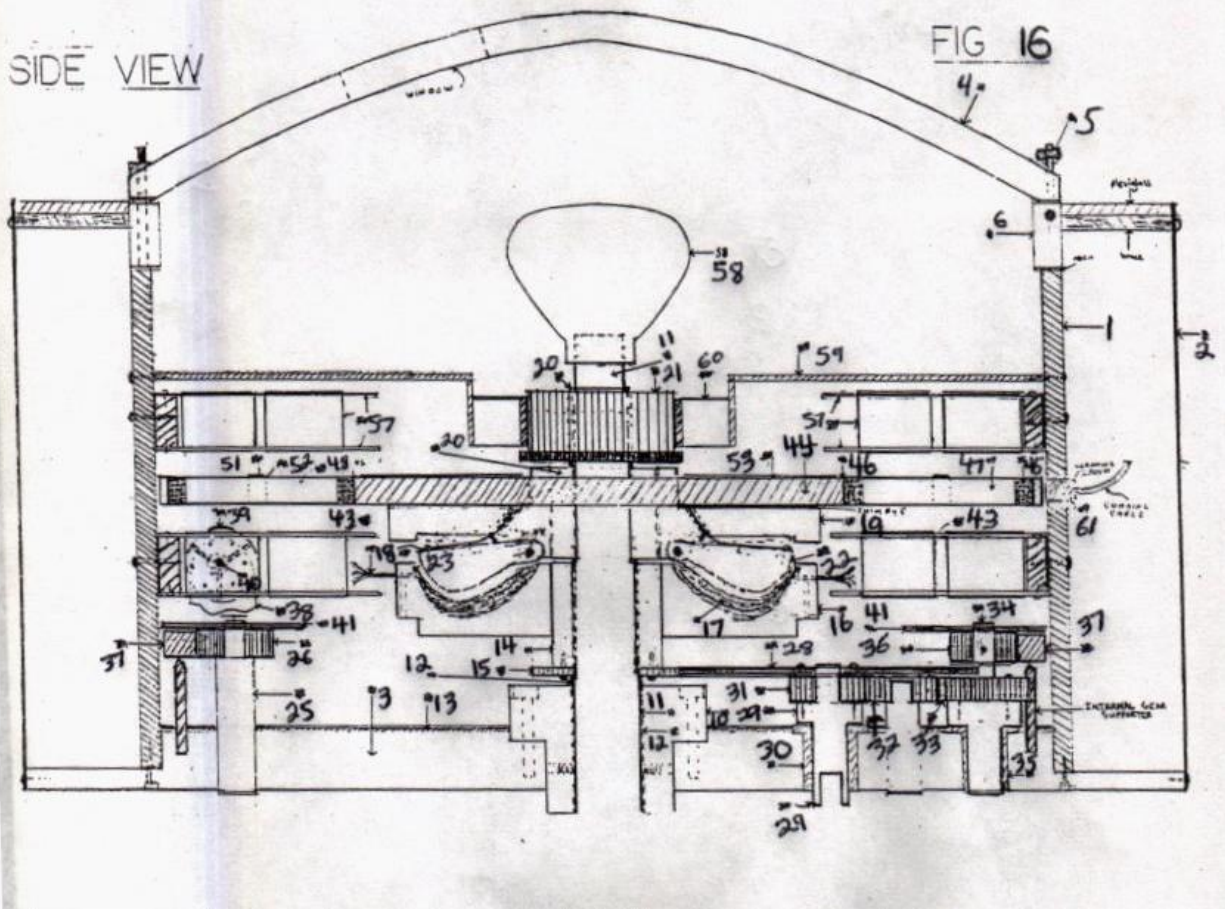

FIG 15



SIDE VIEW

FIG 16



TOP VIEW

FIG. 17

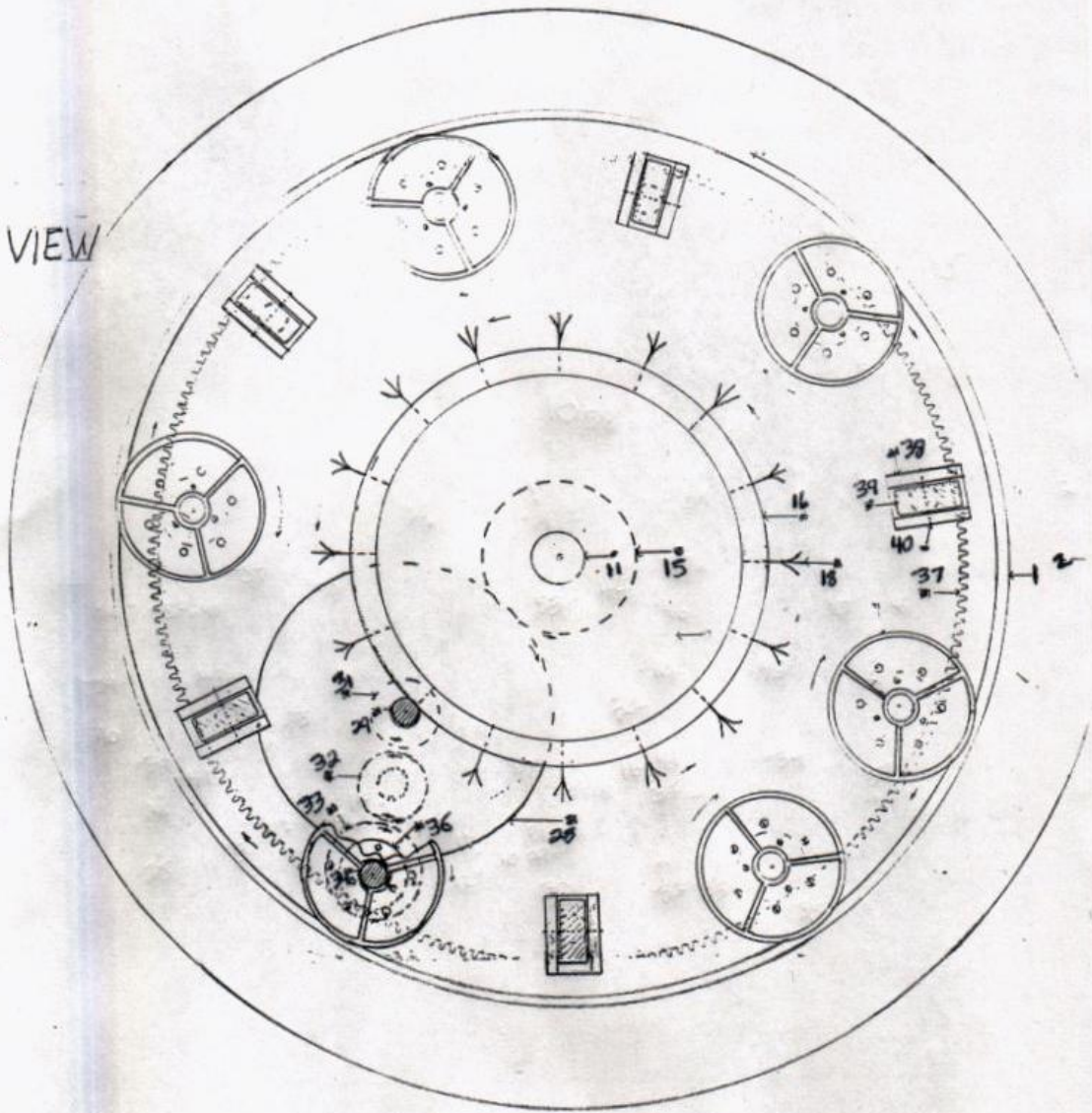

TOP VIEW

FIG 18

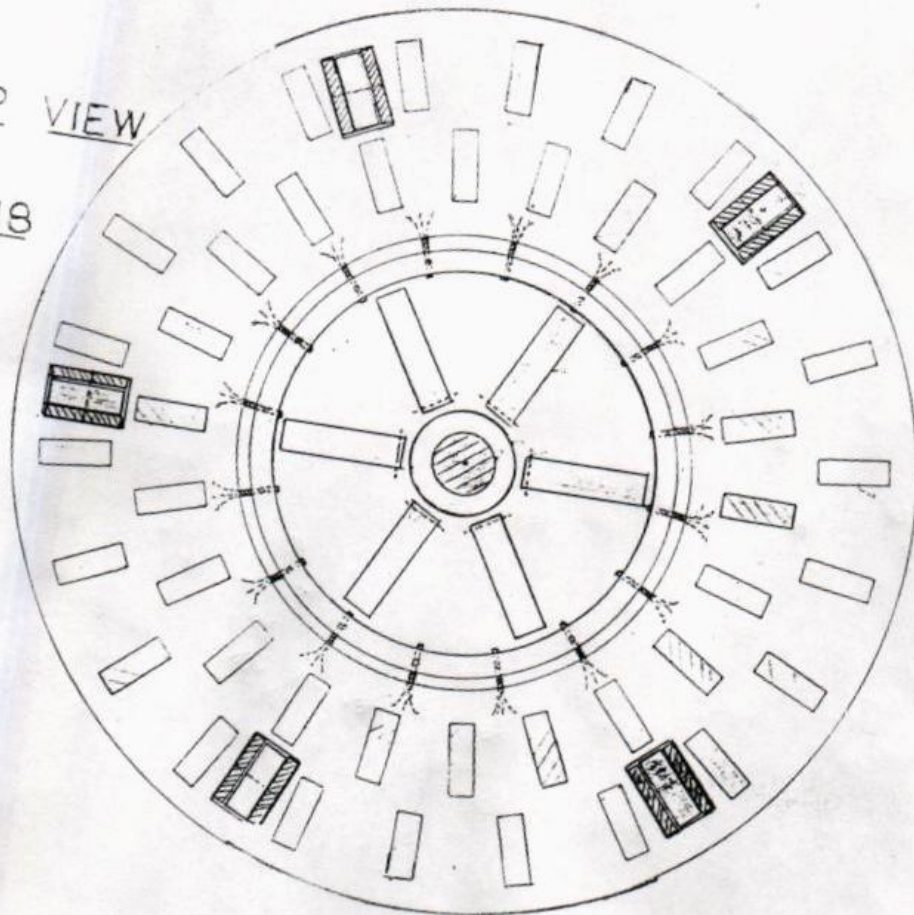

MAGNET
RING
FIG 19

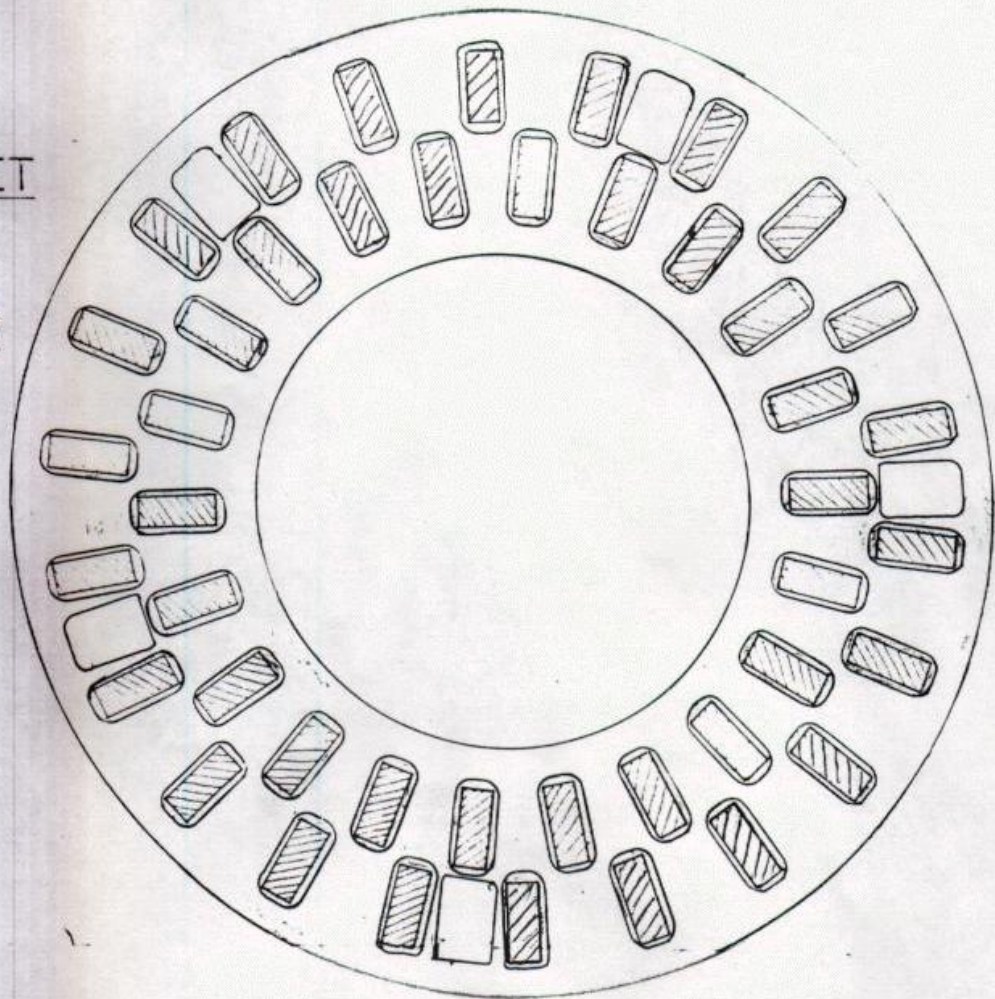

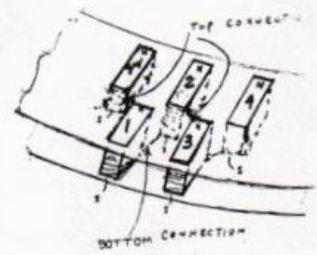
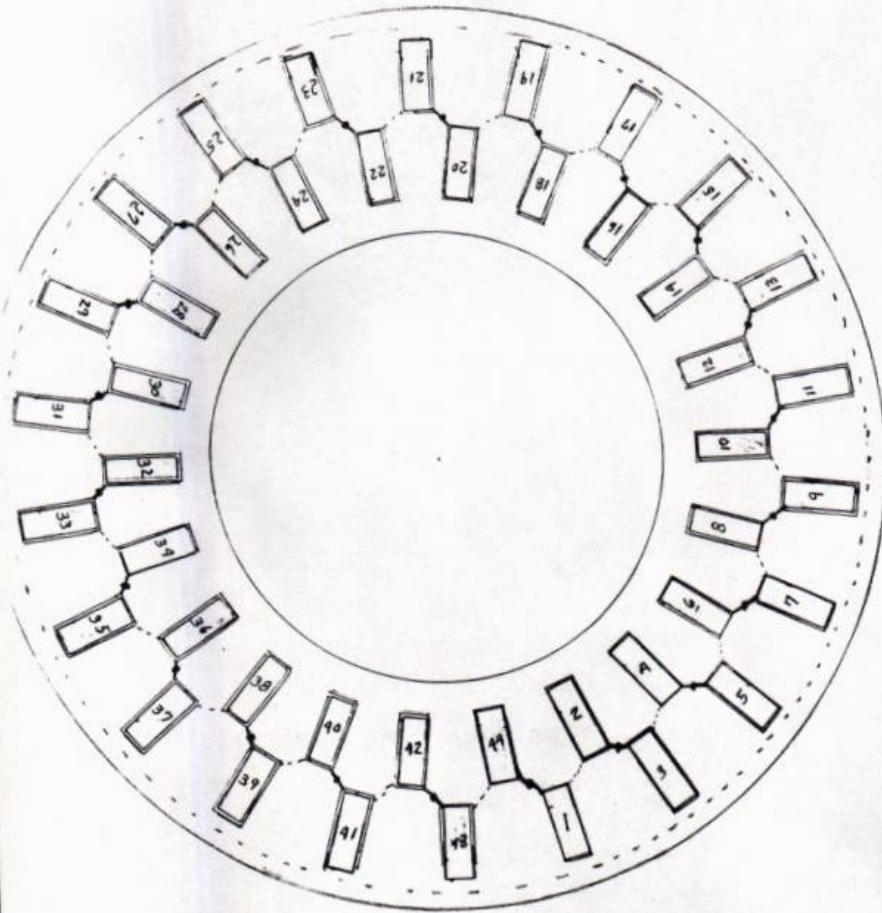

WIRE CONNECTIONS

FIG 20

TOP VIEW

FIG 21

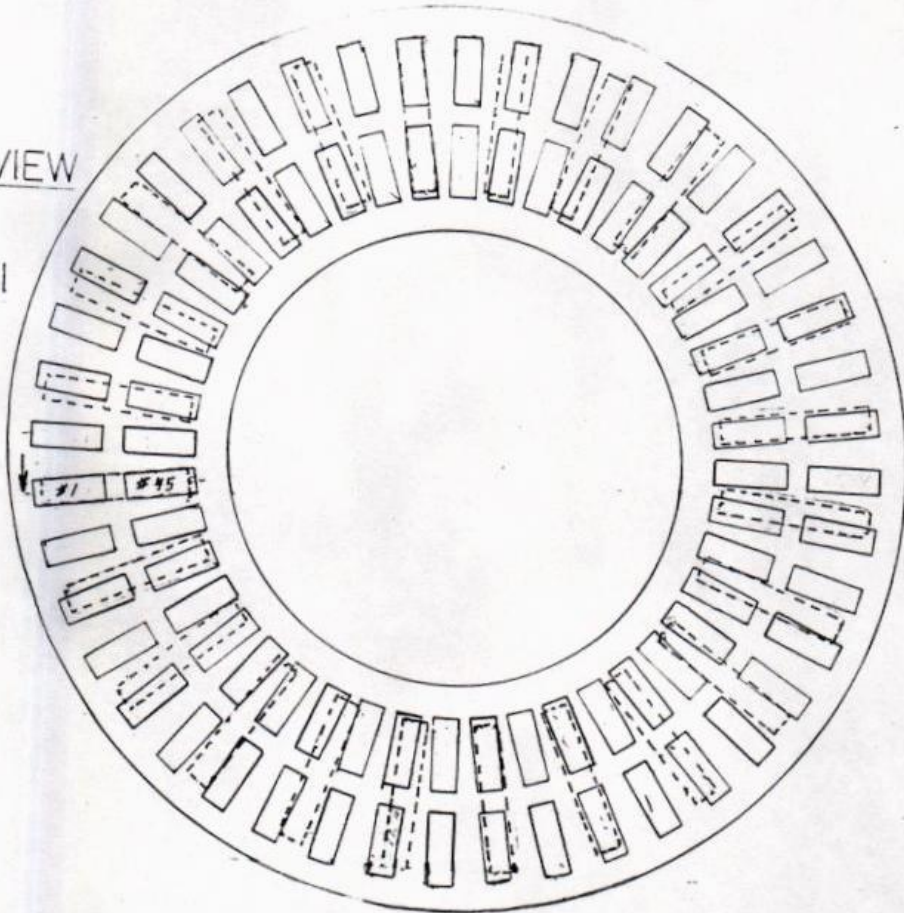

PLASTIC MAGNET PLACEMENT

FIG 22

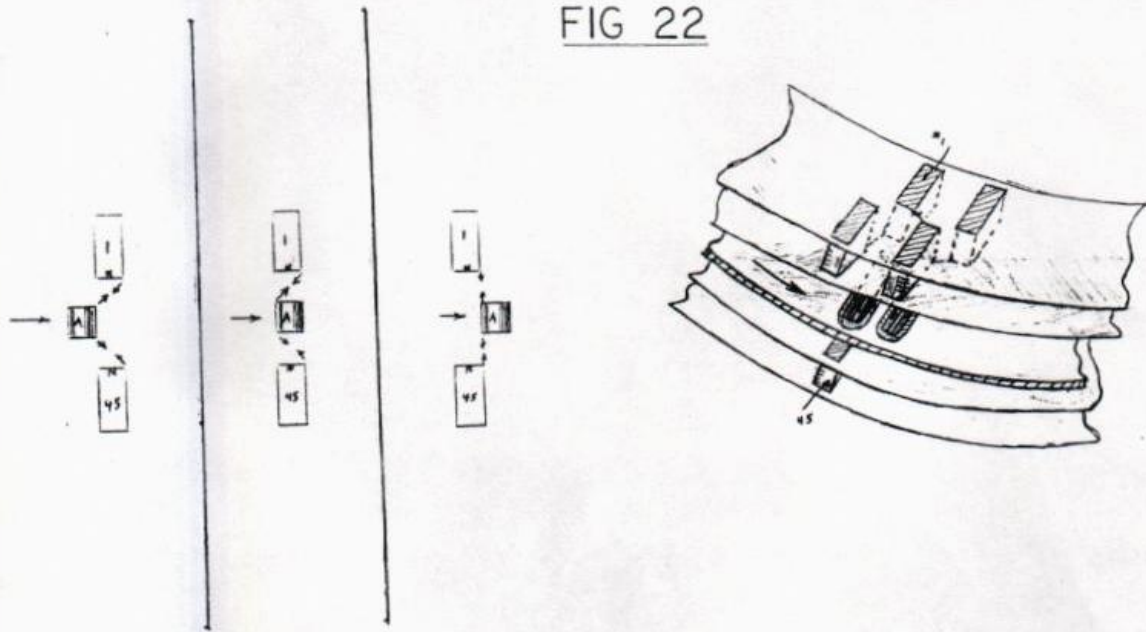
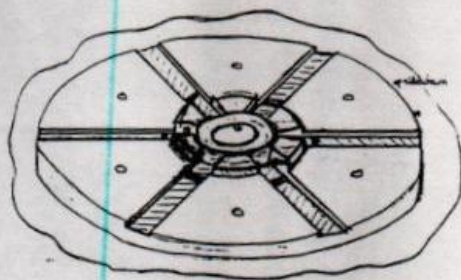
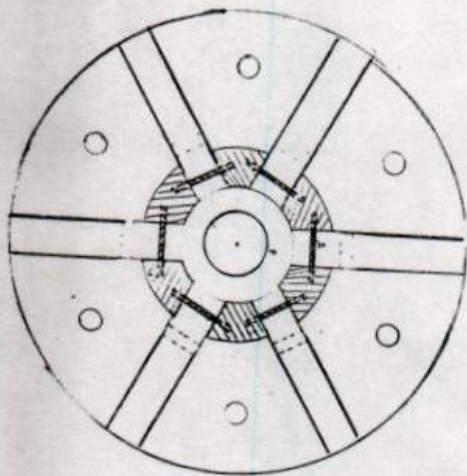
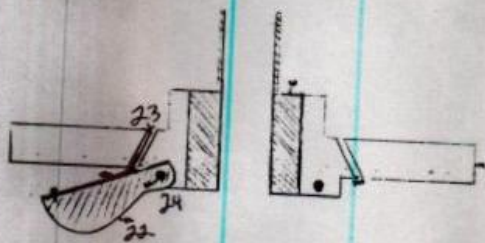
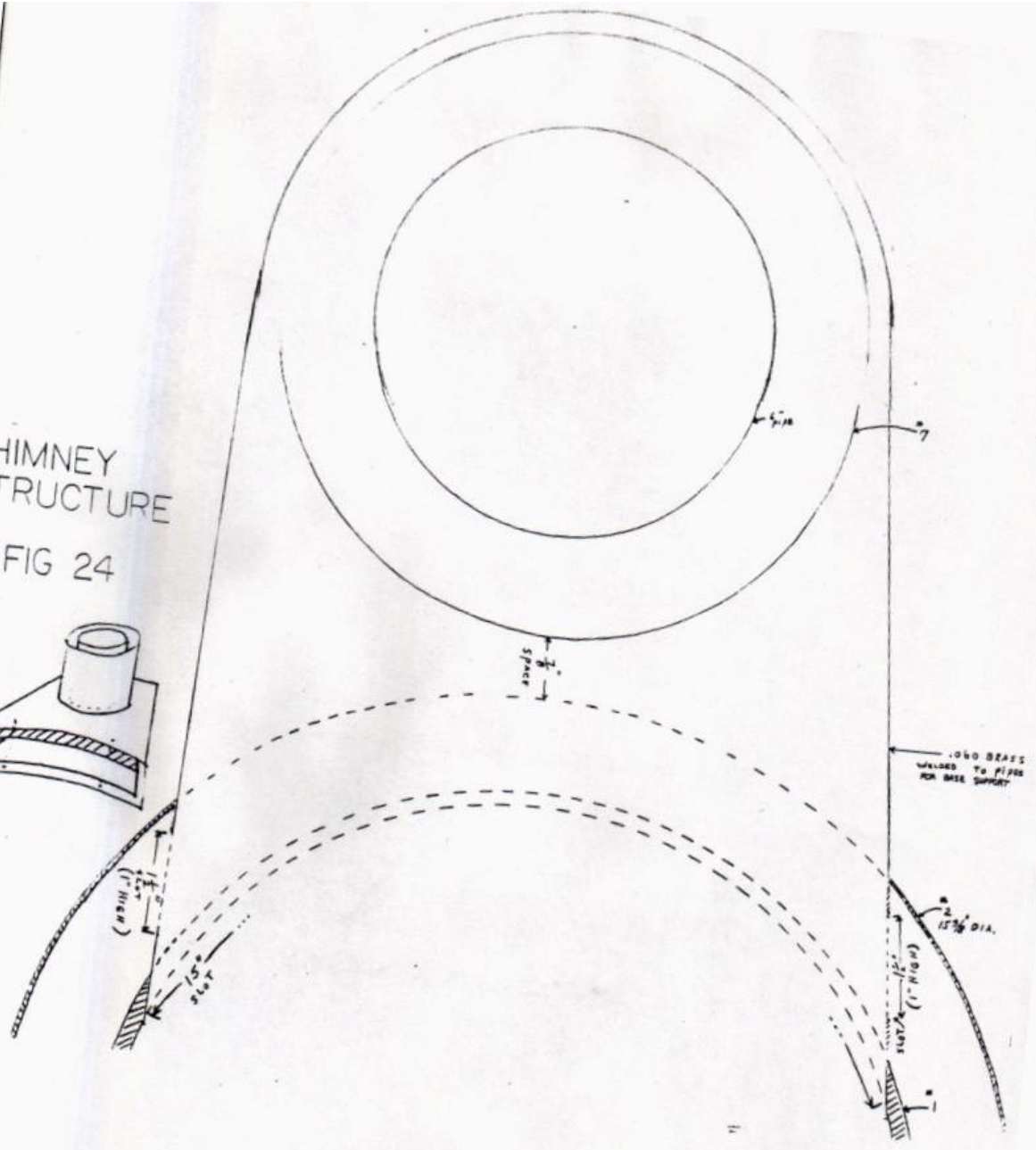
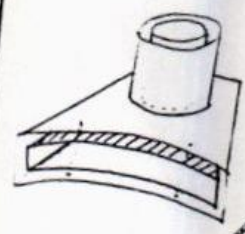

FIG 23



HIMNEY
STRUCTURE

FIG 24



TOP VIEW

FIG 2.5

